

Oakmont/Encore

INSTALLATION INSTRUCTIONS

For quick and easy installation of your folding door, read these instructions thoroughly. A few minutes of prior planning will make the job easier and will ensure years of trouble-free use.

The Tools You Will Need

You will need a small #1 Phillips screwdriver, a flathead screwdriver, a tape measure, a small nail, and a 3/32" drill bit for pilot holes, a hacksaw or fine tooth saw (saw needed to trim top track for the appropriate width or to trim height of panels if door is less than 80" high); and masking tape (to secure doors if trimming is necessary.) Safety glasses. Fine sandpaper (used to smooth edges after trimming.)

Make Sure All The Following Parts Are Included With Your Folding Door:

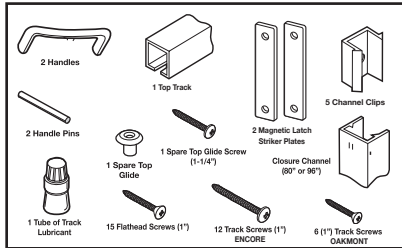

Door Parts Location

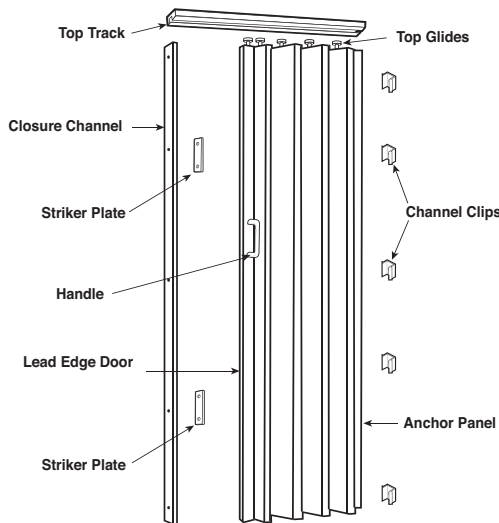

SINGLE DOOR INSTALLATION

1. Measure the Door Opening

If the height of your door opening is approximately 80", you will not need to alter the door itself. If the opening is less than 80"/96" high, the door may be shortened by sawing off excess from the bottom of the door panels.

Stack the door panels together and secure with masking tape. Remove bottom hinge screws. Cut excess with a hacksaw or fine tooth saw. Cut the overhead track 1/8" shorter than the width of the opening. Fine sandpaper may be used to smooth rough edges. Reinsert hinge screws.

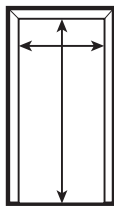

2. Install the Top Track

Position the overhead track on the top of the door opening so that it is straight and centered.

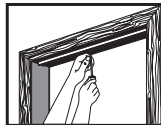

After making a pilot-hole (with a nail or 3/32" drill), drive a 1" track screw through the screw hole nearest the center of the track. Do not tighten. (Tape may be used to hold the track in place while you mark and drill.)

3. Install the Handles

Tap the two handle attachment pins into one handle, then fit the pins through the door panel holes. Press the other handle onto the pins.

If necessary, you may back one handle with a solid object and tap the other handle alternately over each pin area until the handles are seated. Do not strike the middle of either handle.

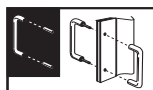

4. Install the Door Panels

Apply track lubricant to each top glide. Swing one end of the overhead track out of the door opening to accept the top glides. Decide if you want the door to open from the left or the right, then slide all top glides onto the track. Stack the panels together near the center screw.

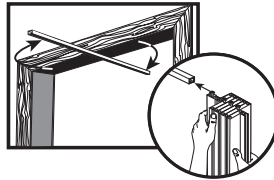

5. Secure The Top Track

Swing the track back to its original position. After making pilot holes (with a nail or a 3/32" drill), drive the 1" track screws through all track holes. Set all screws as straight and tight as possible to assure smooth operation of the door.



6. Secure The Anchor Panel

Use the closure channel to measure and align the channel clips. Align the channel on the non-opening side of the door jamb. Make sure the top of the channel is straight up and down.

Mark each of the five closure channel screw holes and remove the closure channel. Make pilot holes (with a nail or 3/32" drill) and install the channel clips loosely, using five of the 1" roundhead screws. Align the clips vertically and press the door anchor panel onto them until it snaps into place.

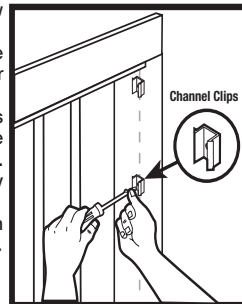

7. Secure The Closure Channel

Align the closure channel on the opening side of the door jamb. Make sure the channel is straight up and down.

Mark each of the five screw holes (as above). If necessary, cut the channel to match door size. Make pilot holes in door jamb (with a nail or a 3/32" drill) and install the closure channel, using five of the 1" flathead screws.

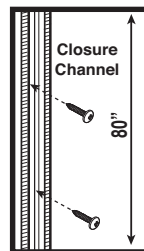

8. Install The Magnetic Latch Striker Plates

Position both of the striker plates inside the closure channel, across from the two magnets on the lead edge of the door. Mark the locations of the striker plate holes on the channel. Make pilot holes (with a nail or a 3/32" drill) in the closure channel. Install the striker plates with four 1" flathead screws.

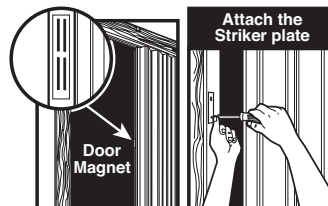

Double Door Installation

1. Measure The Door Opening

Divide the width of the opening by two. Cut each overhead track to this measurement so that when installed, the tracks butt against one another in the center of the door opening. It is also acceptable to use one track if it will fit your opening.

2. Install Top Track

On a center line drawn across the top of the door opening, install either half track and install all screws in the half track. If using a single track, use one center screw.

3. Install The Door Panels

Please lubricate the top glides with the lubricant supplied. Install the two doors in the half track with lead edges facing each other. If necessary install the second track and push one door onto this track. Set a track screw at the track center joint and leave the screw projecting down 1/2" to prevent glides from passing the joint.

4. Secure The Anchor Panel

Use the closure channel to measure and align the channel clips. Align the channel on the non-opening side of the door jamb. Make sure the top of the channel is straight up and down.

Mark each of the five closure channel screw holes and remove the closure channel. Make pilot holes (with a nail or 3/32" drill) and install the channel clips loosely, using five of the 1" roundhead screws. Align the clips vertically and press the door anchor panel onto them until it snaps into place. Repeat on the left door jamb.

5. Install The Closure Channel

Align the closure channel on the lead edge of this door so that it is flush with the top and bottom of the door. Mark each of the five screw holes on the lead edge and drill five pilot holes with 3/32" bit. Install the closure channel using five 1" flathead screws.

6. Install The Magnetic Latch Striker Plates to Closure Channel

If closure channel is not used, it may be necessary to remove the magnets from one door and reverse polarity.

Follow single door installation step number 8 for both sides of the jamb.